

SHORT NOTE ON THE DEPTH OF INVESTIGATION OF ELECTRICAL METHODS

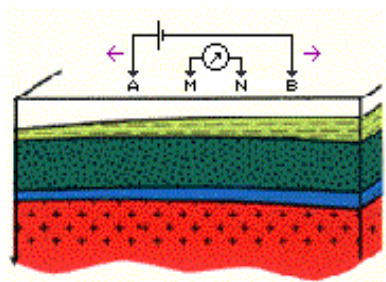

PARAMETERS CONTROLLING THE DEPTH OF INVESTIGATION

DEPTH OF INVESTIGATION OF VERTICAL ELECTRICAL SOUNDING

DEPTH OF INVESTIGATION OF MULTI-ELECTRODE RESISTIVITY IMAGING

**DEPTH OF INVESTIGATION OF MULTI-ELECTRODE RESISTIVITY IMAGING
WITH ROLL ALONG EXTENSIONS**

www.HeritageGeophysics.com
support@HeritageGeophysics.com

J. BERNARD, July 2003

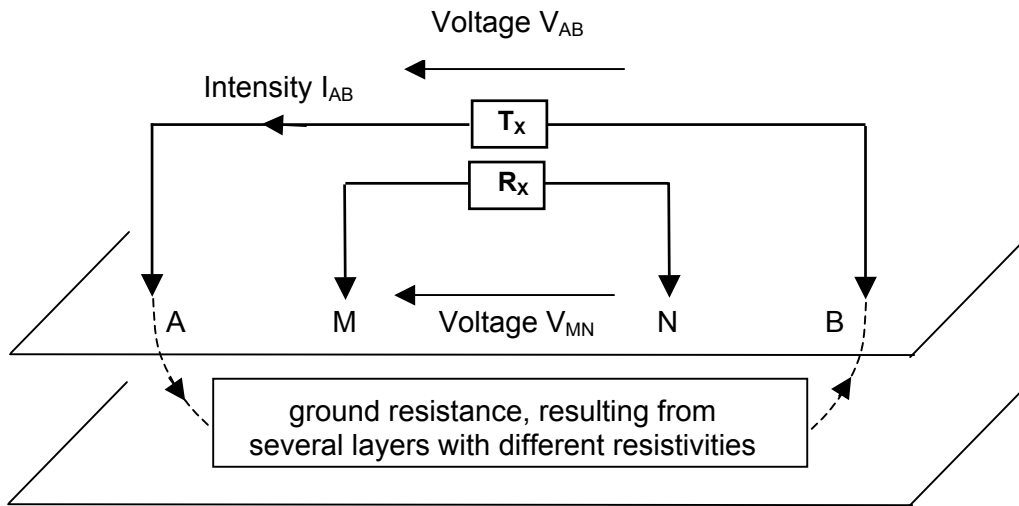

APPARENT RESISTIVITY = (coefficient) x voltage / intensity = $\rho = K \times V_{MN} / I_{AB}$

$K = 2 \times \pi / (1/AM - 1/AN - 1/BM + 1/BN)$

with ρ in *ohm.m*, K in *m*, V_{MN} in *mV*, I_{AB} in *mA*

In the transmitting circuit: $I_{AB} = V_{AB} / R_{AB}$, with V_{AB} in *V*, R_{AB} in *kohm*, I_{AB} in *mA*

**MAIN
ELECTRODE
ARRAYS**

➔ **SCHLUMBERGER SOUNDING AND PROFILING**

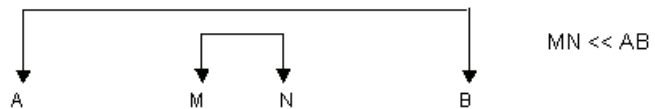

➔ **WENNER SOUNDING AND PROFILING**

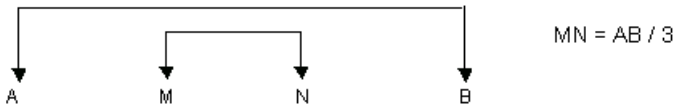

➔ **DIPOLE DIPOLE ARRAY**

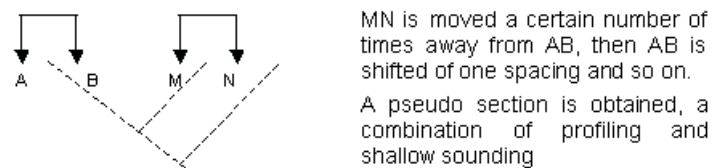

➔ **POLE DIPOLE ARRAY**

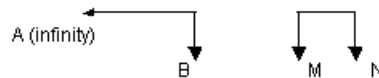

➔ **POLE POLE ARRAY**



Fig 1: PRINCIPLES OF ELECTRICAL METHODS

DEPTH OF INVESTIGATION OF ELECTRICAL METHODS

PRINCIPLE OF ELECTRICAL METHODS (Fig 1)

In electrical methods, a current I_{AB} is transmitted into the ground with two electrodes (A, B), while the difference of potential V_{MN} produced by the circulation of this current into the geological layers is measured with two other electrodes (M, N). The -apparent- resistivity ρ of the ground is defined by the relation $\rho = K \times V_{MN} / I_{AB}$, where K is a geometrical coefficient which depends on the separations between the A, B, M, N electrodes: $K = 2 \pi / (AM^{-1} - AN^{-1} - BM^{-1} + BN^{-1})$.

PARAMETERS CONTROLLING THE DEPTH OF INVESTIGATION

On a theoretical point of view, the depth of investigation of a measurement depends on the length of the transmitting line AB and on the separation between the transmitting AB line and the receiving MN line. Various types of electrode combinations can be used (Schlumberger, Wenner, dipole, pole, gradient arrays, ...), each of them featuring various benefits and limitations in terms of vertical penetration, lateral resolutions, field set-up, but all following the same general rules:

- the larger the length AB, the deeper the penetration of the current
- the farther the M, N receiving electrodes from the A, B transmitting electrodes, the more representative the potential measured on the surface of the ground, of the resistivity of deep layers.

The arrays can be used on a sounding procedure where the depth of investigation is increased at each new reading for a given midpoint, or in a profiling procedure where the spacings between the electrodes is kept constant for all readings, the midpoint of the array being moved of an elementary distance at each new reading. In the profiling procedure, the depth of investigation of the readings is determined by the spacings between the electrodes.

On a practical point of view, the depth on investigation also depends on the measurability of the V_{MN} potential which can be expressed as $V_{MN} = \rho \times I_{AB} / K$. For large investigation depths, the electrodes have to be far away from each other, the K coefficient has thus an important value, and the V_{MN} signal becomes small, possibly difficult to measure. Several factors facilitate a good measurement at large investigation depths:

- a high ground resistivity "rho": a 1000 ohm.m ground (hard rock) produces a V_{MN} signal ten times greater than a 100 ohm.m ground (sedimentary rock) and a hundred times greater than a 10 ohm.m ground (clayey formation). The resistivity parameter, linked to the nature of the rocks, is of course out of the control of the operator
- a high intensity of the current $I_{AB} = V_{AB} / R_{AB}$, which means:
 - a low ground resistance R_{AB} : if the surface layer is a dry sand (which has a very high resistivity), the ground resistance of the A and B electrodes are higher than if it is a clayey soil (which has a very low resistivity). However, it is possible to decrease a ground resistance R_{AB} by using several long stakes at each A and B transmitting points, poured with salt water for instance, which decreases the resistivity of the ground located near to these transmitting points, thus the ground resistance R_{AB} .
 - and/or a high output voltage V_{AB} , obtained with a powerful equipment. The resistivity systems are usually characterized by a maximum current, a maximum voltage and a maximum power, one of these three parameters determining the intensity of the current which can really be transmitted into the ground, in relation with the value of the ground resistance R_{AB} .
- a highly sensitive meter, with filtering capability including stacking / averaging process for noise rejection (Self Potential, drift of SP, power lines fields, other industrial or natural electromagnetic interferences,...), which makes it possible to measure a low V_{MN} amplitude in an as-short-as-possible acquisition time.

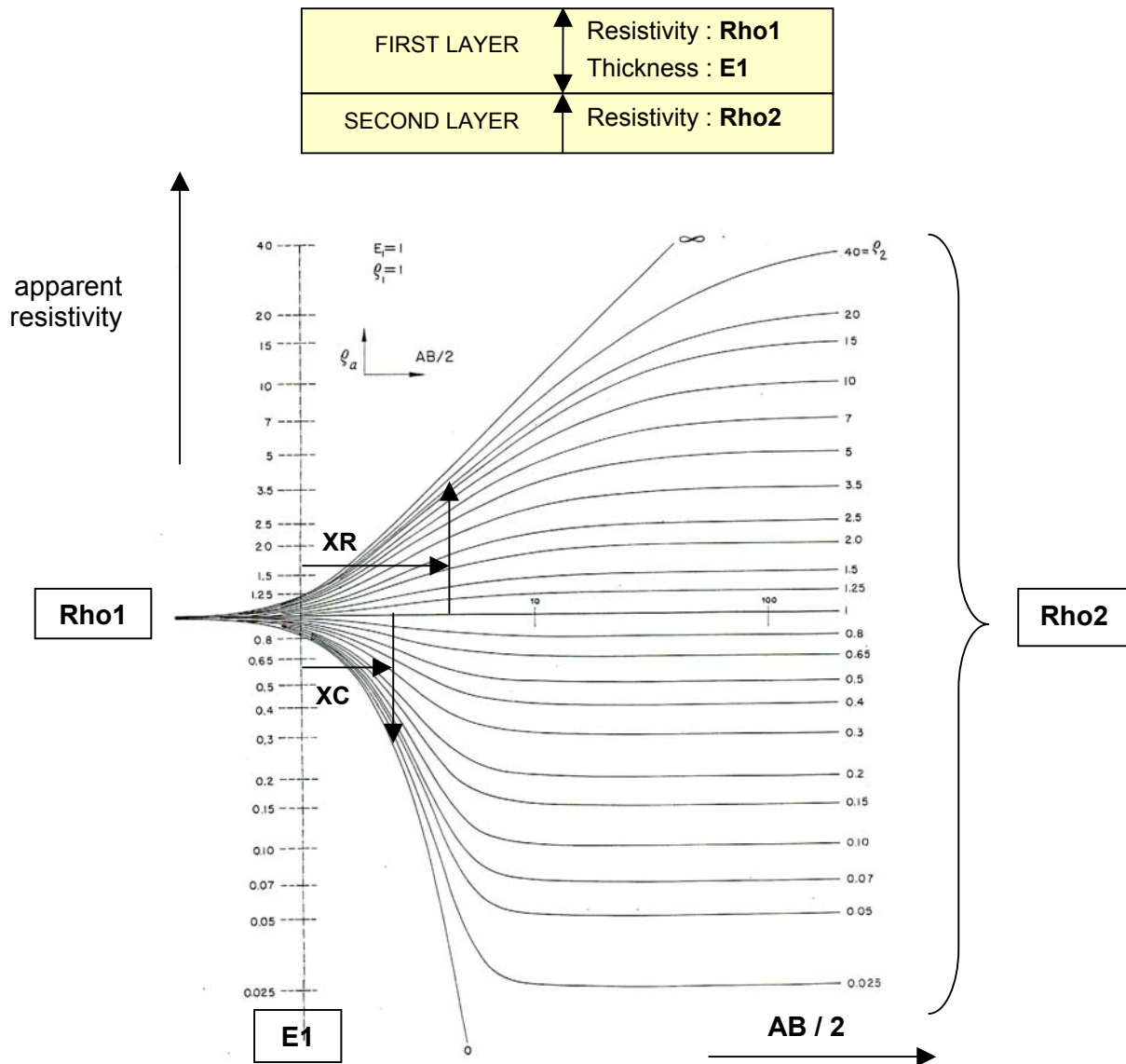

In case of a two layer sounding, when the second layer is more resistive than the first one, its presence is observed in the apparent resistivity curve for a length of line $AB/2$ longer than when the second layer is more conductive. In the figure, XR is longer than XC , for the same relative variation of the apparent resistivity curve.

Fig 2: TWO LAYER MASTER CURVES FOR SCHLUMBERGER 1D SOUNDINGS

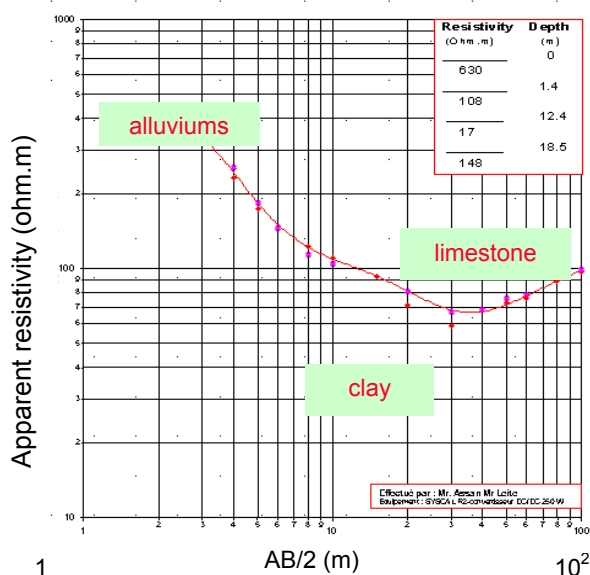

EXAMPLE OF INTERPRETATION OF A 1D SCHLUMBERGER SOUNDING

DEPTH OF INVESTIGATION OF VERTICAL ELECTRICAL SOUNDING (VES) (Fig 2)

In the VES technique, the ground is supposed to be composed of horizontal layers. It is a common rule of thumb to say that the depth of investigation is of the order of 0.1 to 0.3 times the AB length: a 1km AB line leads to a depth of 100 to 300m, depending on the type of layering (for instance, a conductive basement can be seen with a shorter AB line than a resistive one; however, the signal is normally lower in the first case than in the second one).

In a traditional Schlumberger or Wenner electrical sounding, the transmitting A and B electrodes are successively moved away from each other at each new reading to increase the depth of investigation. The operator fully controls the AB and MN lengths, as the four electrodes and their wires are independent. As the time necessary to move from one position to the next one becomes longer and longer for deep investigations, it is reasonable in these soundings to spend a significant time to stack the signal so as to improve the quality of the reading or to make this reading possible.

DEPTH OF INVESTIGATION OF MULTI-ELECTRODE RESISTIVITY IMAGING (Fig 3)

Recently, a new concept of equipment has been introduced to make it possible the acquisition of many readings in a reduced amount of time for environmental applications corresponding to rather shallow investigations depths, of the order of 10 to 50m. The technique is sometimes called Electrical Resistivity Imaging (ERT).

The concept consists in using multi-core cables which contain as many individual wires as number of electrodes, with one take-out every 5m, 10m, ... and 24, 48, 72, 96, ... electrodes. The measuring unit includes relays which automatically carry out the sequences of readings introduced in its internal memory. The aim of this set-up is to take readings for many combinations of transmission and reception pairs, so as to achieve some kind of mixed profiling / sounding array. In such a way of proceeding, the total length of cable is the product of the electrode spacing by the number of electrodes: 240m for 48 electrodes at 5m spacing, which determines the maximum depth of investigation, on contrary to the classical VES technique where it is always possible to add new reels of wire to increase the separation between the A and B transmitting electrodes.

For Schlumberger, Wenner and Dipole - Dipole types of electrode arrays, the maximum depth of investigation is of the order of 0.2 times the total length of cables, for instance 50m for 48 electrodes spaced at 5m (total length: 240m). For Pole Pole arrays where one electrode of current and one electrode of potential are placed far from the measuring line, the depth of investigation is increased to 0.9 times the length of the multi-core cable (220m in the previous example). See Dr Loke's Tutorial on 2D & 3D electrical imaging surveys at "geoelectrical.com" for more details.

For these multi-electrodes profiles, the number of readings which are taken for a given spread of line is quite high compared to the traditional four electrode soundings (easily a few hundreds readings). It is the reason why the acquisition time for one reading (which is repeated so many times to obtain the full image) is quite determinant for the efficiency of the survey, and the highest the power of the equipment, the lowest the duration of the field work.

DEPTH OF INVESTIGATION OF MULTI-ELECTRODE RESISTIVITY IMAGING WITH ROLL ALONG EXTENSIONS

The maximum depths here above mentioned are obtained when the electrodes located at the extremity of the line are addressed. This corresponds to one only point which is the middle point of the array. When the line to prospect is longer than the length of the multi-core cable, a roll along procedure is usually used where the first segment of the multi-core cable is moved to the extremity of the cable to enable further readings.

For instance, if a 48 electrode 240m long initial line consists in two segments of 120m with 24 electrodes spaced at 5m for each segment, the minimum displacement consists in one segment of 120m. This makes that the continuity of the image will be only ensured for half the maximum depth of the array as reported in the previous paragraph (see figure 3 for visual understanding).

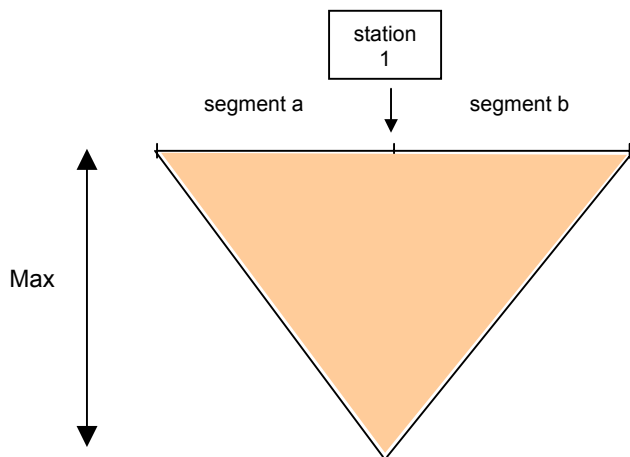

AREA INVESTIGATED
 with one set of readings of a multi-electrode sequence. The equipment is placed in the middle (station 1) of the multi-core cable composed of two segments, a and b.
The maximum depth reached, referred to as Max, depends on the electrode arrays used. For Wenner and dipole dipole arrays, this Max depth is estimated to 0.2 L, L being the total length of the cable (segment a + segment b)

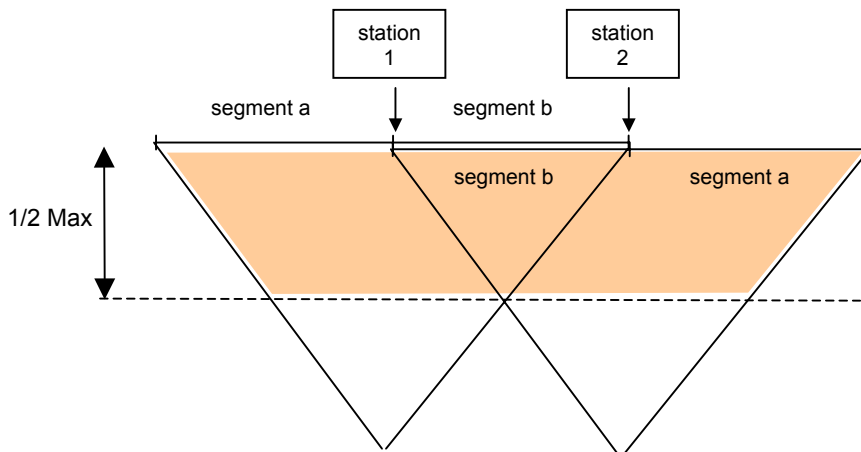

In case of a roll along procedure with a two segment cable (a and b), a first sequence of readings is taken with the equipment located in station 1, using the segments a and b.
 Then, a second sequence is taken with the equipment moved to station 2, using the segments b and a.
The maximum depth reached which ensures a continuity of the bottom part of the image is 1/2 Max

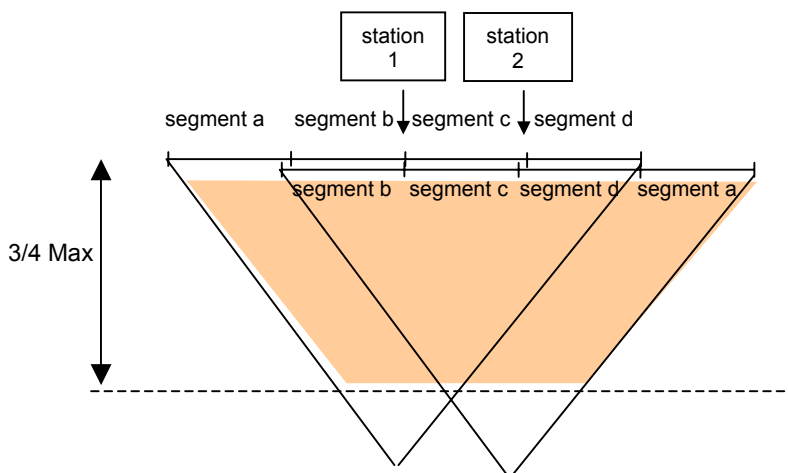

In case of a roll along procedure with a four segment cable (a, b, c and d), a first sequence of readings is taken with the equipment located in station 1, in the middle of the segments a, b, c and d.
 Then, a second sequence is taken with the equipment moved to station 2, in the middle of the segments b, c, d and a.
The maximum depth reached which ensures a continuity of the bottom part of the image is 3/4 Max

number of electrodes	electrode spacing	Total line length L	Max depth for a sequence (about 0.2 L)	number of segments	Max depth in roll along sequences (one segment translation) ensuring a continuity of the bottom part of the image
48	5m	240m	48m	2	1/2 Max = 24m
	10m	480m	96m	4	3/4 Max = 64m
72	5m	360m	72m	4	3/4 Max = 48m
	10m	720m	144m	6	5/6 Max = 128m

Fig 3: EXAMPLES OF MAXIMUM DEPTHS OF INVESTIGATION OBTAINED WITH A MULTI-ELECTRODE SYSTEM, FOR A WENNER OR A DIPOLE DIPOLE ARRAY

As another example, one can consider the case of a 72 electrode 360m long initial line consisting in four segments of 90m of 18 electrodes each spaced at 5m, the roll along can be made by moving one segment of 90m, which makes that the maximum depth which will ensure a continuity of the image is the three fourths of the maximum depth mentioned earlier.

More generally, when a cable is composed of n segments, the maximum depth enabling a continuity of the bottom line of the image during roll along sequences with a unitary translation of 1 segment for each new sequence is equal to (n-1)/n times the maximum depth obtained with the initial sequence.

The table of figure 3 summarizes some numerical applications of this rule for various usual types of cables and number of electrodes.

CONCLUSIONS

It must be pointed out that the depth of investigation in electrical methods depends on two main factors: on the one hand the geometry of the cables (type of array, number of electrodes, spacing between electrodes, number of segments); on the second hand on the measurability of the signal by the equipment, namely the amplitudes of the signal and of the existing noise, the power specifications of the equipment and its ability of filtering the noise through the stacking process.

Equipment		SYSCAL Junior	SYSCAL R1 Plus	SYSCAL Pro 1 channel	SYSCAL Pro 10 channels
Max voltage & power		400V, 100W	600V, 200W	800V, 250W	800V, 250W
Max current at 2.5kohm		160mA	240mA	320mA	320mA
Average measured signal in the section	for 1000 ohm.m ground resistivity	100mV 3 stacks, 20 mn	150mV 3 stacks, 20mn	200mV 3 stacks, 20mn	200mV 3 stacks, 2mn
	for 100 ohm.m ground resistivity	10mV 6 stacks, 30mn	15mV 5 stacks, 25mn	20mV 3 stacks, 20mn	20mV 3 stacks, 2mn
	for 10 ohm.m ground resistivity	1mV 40 stacks, 1h40mn	1.5mV 30 stacks, 1h20mn	2mV 20 stacks, 1h	2mV 20 stacks, 6mn

Fig 4: TABLE GIVING AN ESTIMATE OF THE AMPLITUDE OF THE SIGNAL MEASURED IN A RESISTIVITY IMAGING SECTION, IN RELATION WITH THE MAXIMUM OUTPUT VOLTAGE OF THE EQUIPMENT

The values of the apparent resistivity of the ground are 1000, 100, and 10ohm.m

The ground resistance of the electrodes is supposed to be 2.5kohm.

The measured signal is computed as a rough average of a Pole Dipole array in a roll along sequence, with 48 electrode system at 5m spacing, for a total of 500 readings.

The number of stacks "n" is related to a 1% quality of reading, for a standard noise, with 250ms pulses

The duration of the survey expressed in h-mn is given as an indication, for comparison purposes. In practise, the duration depends on the local noise (SP and EM effects, ...) and on the quality of the readings required.

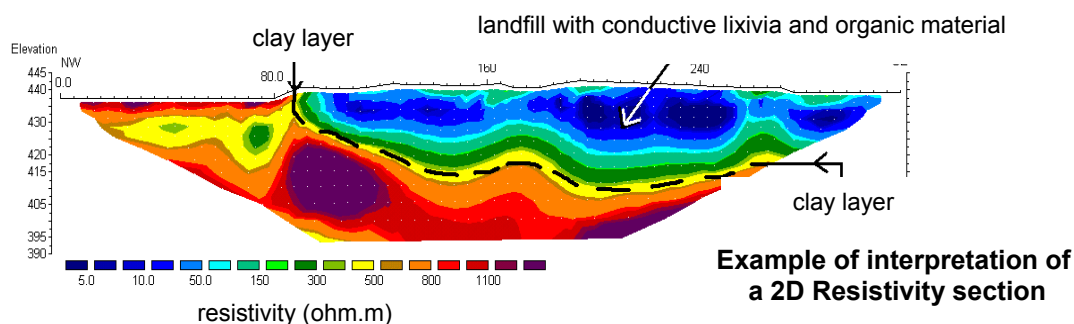



SYSCAL Junior resistivity meter



Multinode unit

GEOPHYSICAL INSTRUMENTS FOR ELECTRICAL PROSPECTING



Switch unit



SYSCAL Pro Switch 48 imaging resistivity system

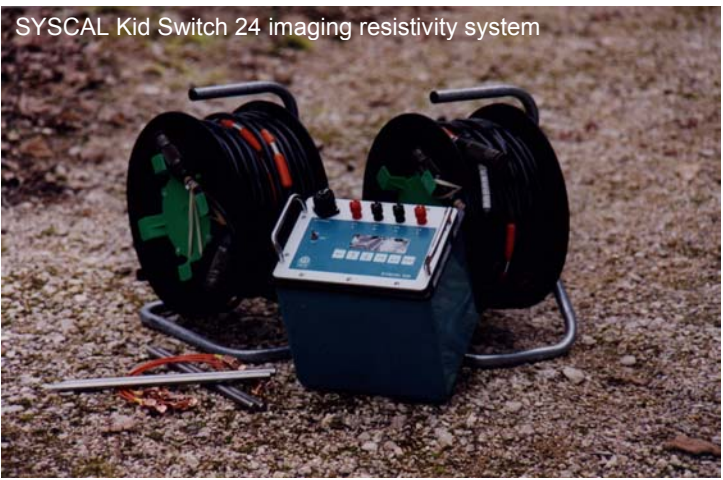

SYSCAL Kid Switch 24 imaging resistivity system



SYSCAL R2 resistivity meter



SYSCAL R1 Plus resistivity meter



SYSCAL R1 Plus Switch 48 imaging resistivity system